

# SHARP



Refrigerant: R600a  
Insulation blowing gas: Cyclopentane

製冷劑：R600a  
絕熱發泡氣體：環戊烷



**SJ-P22M**  
**SJ-P25M**

## Refrigerator - Freezer Operation manual

### Contents

• Safety information .....	EN-1
• Installation.....	EN-3
• Description .....	EN-4
• Controlling temperature.....	EN-5
• Storing food .....	EN-6
• Care and cleaning.....	EN-7
• Before you call for service.....	EN-8

## 原裝進口雪櫃 使用說明書

### 目錄

• 安全注意事項 .....	ZH-1
• 安裝 .....	ZH-3
• 各部位名稱 .....	ZH-4
• 實用功能 .....	ZH-5
• 食品的儲存 .....	ZH-6
• 保養 .....	ZH-7
• 送修之前的初步檢查.....	ZH-8

ENGLISH

中文







Thank you very much for buying this SHARP product. Before using your SHARP refrigerator, please read this operation manual to ensure that you gain the maximum benefit from it.

- This refrigerator is intended for making ice cubes, refrigerating and freezing foods.
- This refrigerator is for household use only, with ambient temperature indicated in the table. The climate class is specified on the rating plate. If the refrigerator operates out of range (ambient temperature range) of the climate class which is rated for that model, it may not be able to maintain satisfactory internal temperatures. If the refrigerator is used at colder temperatures, the refrigerator will not be damaged up to a temperature of +5°C.
- The refrigerator should not be subjected to temperatures of -10°C or below for a long period of time.

Household use only	
Climate class	Acceptable range of ambient temperature
SN	+10°C to 32°C
N	+16°C to 32°C
ST	+16°C to 38°C
T	+16°C to 43°C

## Safety information

 <b>WARNING</b>	This means that there are high risks of death or serious injury.
 <b>CAUTION</b>	This means that there are high risks of material damage or personal injury.
 <b>CAUTION</b>	Fire marks means this refrigerator has risk of fire accident.



### WARNING

#### Refrigerant

This refrigerator contains flammable refrigerant (R600a: isobutane) and insulation blowing gas (cyclopentane). Observe the following rules to prevent ignition and explosion.

- Do not allow any sharp objects to have contact with the refrigeration system. The refrigeration system behind and inside the refrigerator contains refrigerant.
- Do not use mechanical devices or other means to accelerate the defrosting process. (This refrigerator has adopted automatic defrosting system.)
- Do not use electrical appliances inside the refrigerator.
- Do not block the space around the refrigerator.
- Do not use flammable sprays, such as spray paint near the refrigerator.
- In the case of failure of the refrigeration system, do not touch the wall socket and use open flames. Open the window and air out the room. Then ask a service agent approved by SHARP for service.

#### Power cord, Plug, Socket

Read carefully the following rules to prevent electric shock or fire.

- Make sure to protect the power cord from being damaged during installation or moving. If the power plug or cord is loose, do not insert the power plug.
- Do not place multiple portable socket-outlets or portable power supplies at the rear of the refrigerator.
- Connect the power plug into the wall socket firmly and directly. Do not use an extension cord or adapter plug.
- Connect the power plug to the socket with the required rated voltage.
- Connect the earth pin to the earth terminal properly.
- Do not touch the power plug with wet hands.
- Disconnect from the main electricity supply by removing the main plug from the socket. Do not remove by pulling the power cord.
- Dust deposited on the power plug may cause fire. Wipe it off carefully.

- Pull out the plug if the refrigerator is not used for a long time.
- If the flexible supply cord is damaged, it must be replaced by service agent approved by SHARP in order to avoid a hazard.

#### Installation

- Do not install the refrigerator in a damp or wet location. It may cause the damage to the insulation or electrical leak. Dew may also appear on the outer cabinet and it causes rust.
- The refrigerator should be installed flatly and firmly on the floor.
- Keep ventilation openings.

#### In use

- Do not store volatile and flammable materials such as ether, petrol, propane gas, aerosol cans, adhesive agents and pure alcohol etc. These materials are easy to explode.
- Do not store temperature-sensitive products such as pharmaceutical products in the refrigerator. There are high risks of changes in product quality.
- Do not attempt to change or modify this refrigerator. This may result in fire, electric shock or injury.
- Do not place bottled drinks and cans in the freezer compartment.
- Do not place any object on the top of refrigerator. If the object falls down from the top, it may cause injury.
- This appliance can be used by children aged from 8 years or above and persons with reduced physical, sensory or mental capabilities or lack of experience and knowledge if they have been given supervision or instruction concerning use of the appliance in a safe way or understanding the hazards involved. Children shall not play with the appliance. Cleaning and user maintenance shall not be done by children without supervision.

## Care and Cleaning

- Unplug the refrigerator first to prevent electric shock.
- Do not splash water directly on the outer cabinet or the interior. This may lead to rusting and deterioration of the electrical insulation.

## Trouble

- If you smell something burnt, pull out the power plug immediately. Then ask a service agent approved by SHARP for service.
- In case of gas leak, ventilate the area by opening window. Do not touch the refrigerator or the power socket.



## CAUTION

### Transportation

- When you install or move your refrigerator, use curing mat to protect the floor from being damaged.
- Carry the refrigerator securely. If you lift up the refrigerator improperly, it may cause injury.

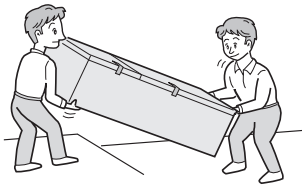

- Do not use the doors to carry the refrigerator.



- Make sure to contact the authorized service center before you install or move the refrigerator.

## Disposal

- Ensure that the refrigerator presents no danger to children while being stored for disposal. (e.g. remove the magnetic door seals to prevent child entrapment.)
- This refrigerator should be disposed appropriately. Take the refrigerator to a professional recycling plant for flammable refrigerant and insulation blowing gases.

### In use

- Do not touch the compressor unit or its peripheral parts, as they become extremely hot during operation and the metal edges may cause injury.
- Do not touch foods or metal containers in the freezer compartment with wet hands. This may cause frostbite.
- Do not use other than potable water to make ice cubes.
- Do not place bottled drinks and cans in the freezer compartment.
- Do not open or close the door when other people put a hand near the door. There is a risk that the other people may get their fingers caught in the door.
- Do not put oversized object in the pockets of the door. If the object falls down from the pockets, it may cause injury.
- Make sure to handle the glass shelves with care to install or uninstall. If you drop the glass shelves, it may break or cause injury.

- 1** Keep adequate ventilation space around the refrigerator.
- The picture shows the minimum required space for installing the refrigerator. The measurement condition of energy consumption is conducted under a different space dimension.

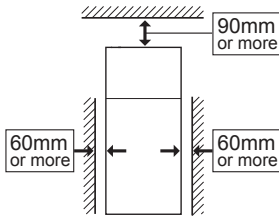

## Rear clearance

The space between the rear of the refrigerator and the wall should be 50mm or more, and less than 75mm. If the space is wider than 75mm, you may get injured by touching compressor and its peripheral parts which are extremely hot during the operation.

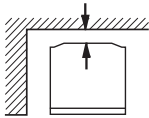

### Note

- By keeping greater space, the refrigerator may consume a less amount of power consumption.
- If use the refrigerator in the smaller space dimension than figured, it may cause temperature rise in the unit, loud noise and failure.
- Do not push the refrigerator against the wall. The wall surrounding the refrigerator may get dirty or discolored because of the air flow caused by heat radiation.

## Overall space required in use

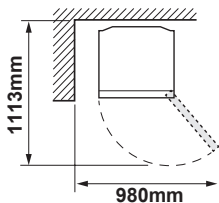

- 2** Use the adjustable foot to place the refrigerator flatly and firmly on the floor.

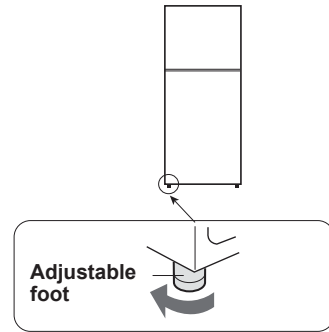

### Note

- Place your refrigerator to access the plug.
- Keep your refrigerator out of direct sunlight and do not place next to heat generating appliance.
- Do not use shipping materials as a stand. Place the refrigerator on a hard floor, not directly on the earthen floor. In the case of placing the refrigerator on the earthen floor, use an appropriate base such as a wooden board under the refrigerator.

## Before using your refrigerator

- Clean the inside parts with a cloth soaked in warm water. If soapy water is used, wipe it off thoroughly with water.
- Remove packing materials (cushion, blue tapes etc.).

# Description

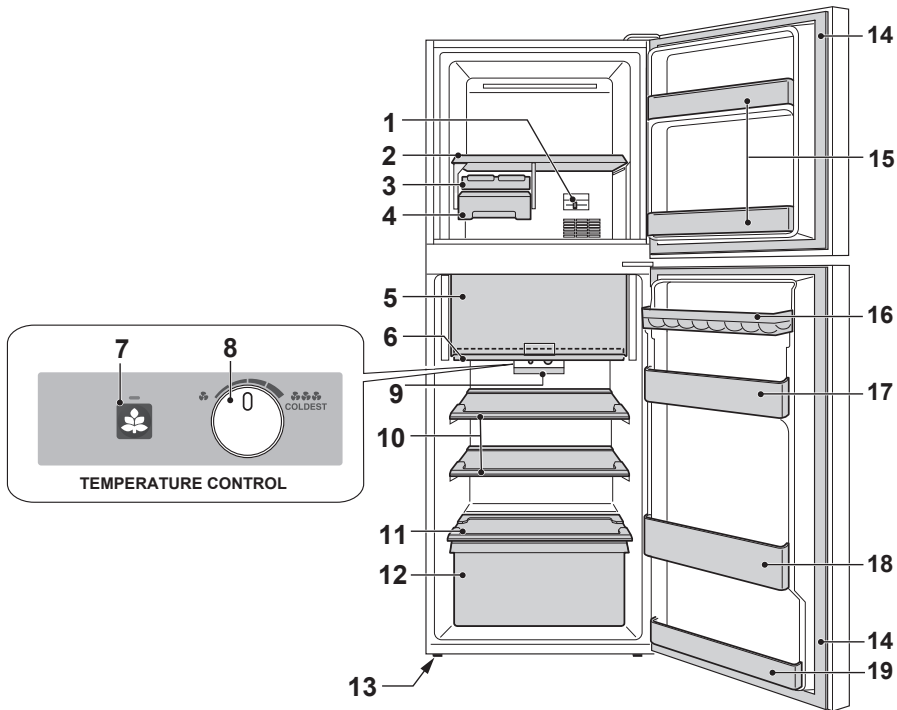

1. Temperature control lever
2. Freezer shelf
3. Ice cube maker

- 1) Do not overfill this tray with water. Otherwise the ice cubes will join together when frozen.
- 2) When ice cubes are made, turn the lever clockwise to put the ice into the ice cube box.

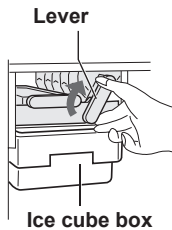

4. Ice cube box
- Note**

To prevent the ice cube box from being damaged, do not pour oil into the box or make ice in it.

5. Two-way fresh room door

Open

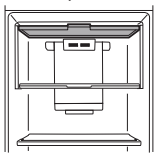

Use the space as refrigerator room.

Close



Use the space as fresh room.

5. Fresh shelf
7. Energy saving button
8. Temperature control knob
9. LED light
10. Refrigerator shelf
11. Vegetable shelf
12. Vegetable case
13. Adjustable foot
14. Magnetic door seal
15. Freezer door pocket
16. Egg pocket
17. Refrigerator door pocket
18. Bottle pocket
19. Utility pocket

## Deodorizing unit

Deodorizing catalyst is installed on the routes of cold air. There is no need to operate and clean.

## If you wish to store large items within your refrigerator

- You may remove any shelves or any pockets numbered 2,3,4,6,10,11,12,15,16,17,18,19 in the picture above.
- Energy consumption of this model is measured without the ice cube maker and the ice cube box in accordance with the international standards.

## How to open Two-way fresh room door

- 1) Lift up the door.
- 2) Insert the door into the frame and push it back to the stopper. It is locked properly.

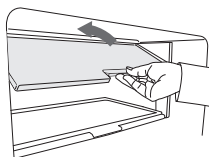

# Controlling temperature

## Temp. control knob (in the refrigerator compartment)

The default setting of this knob is shown in below picture. This knob is for adjusting the cooling strength of the refrigeration system according to the temperature in the refrigerator compartment.

When the knob is turned to "COLDEST" side, both compartments (refrigerator compartment and freezer compartment) are cooled well.



## Temp. control lever (in the freezer compartment)

Set the lever to the center for normal use.

This lever is to open or close the air passage to the refrigerator compartment.

When the lever is slide to "COLDEST" side, only the freezer compartment is cooled well.

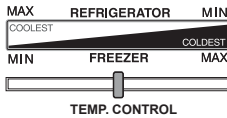

Position of the lever	Condition
Left	<ul style="list-style-type: none"> <li>• Cold air flows into the <b>refrigerator compartment</b> more.</li> <li>• The <b>refrigerator compartment</b> is cooled well.</li> </ul>
Right	<ul style="list-style-type: none"> <li>• Cold air flows into the <b>freezer compartment</b> more.</li> <li>• The <b>freezer compartment</b> is cooled well.</li> </ul>

Recommended temperature settings are shown below.

	Temp. control lever	Temp. control knob
Normal		
In winter (Colder than 10°C)	<ul style="list-style-type: none"> <li>• Set to the right.</li> <li>• Do not set to left side.</li> </ul>	

## Energy saving

Use this mode when you want to switch the refrigerator to energy-saving operation.

While this mode is operating, the inside temperature of the refrigerator and freezer compartment becomes higher than the normal operation as follows.

	Freezer compartment	Refrigerator compartment
Under "Energy saving" mode	Approx. 3°C plus	Approx. 4°C plus

Cancel this mode when you feel the beverages are not cooled enough or ice making takes longer time.

### How to start the operation

Press "Energy saving" button.

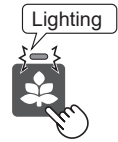

### How to cancel the operation

Press "Energy saving" button again.

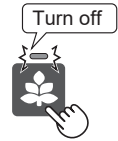

### Note

- The efficiency of power saving depends on the usage environment (controlling temperature, ambient temperature, frequency of opening or closing the door, amount of food).

# Storing food

- Ensure that the food is of the freshest possible quality to maximize the storage life of perishable food. The following is a general guide to help promote longer food storage.
- Food has a limited storage life. Make sure not to exceed use-by date indicated by manufacturer.

## Fruit / Vegetables

Fruit and vegetables should be loosely enclosed in a plastic material e.g. wrap, bags (do not seal) and placed in the vegetable case to minimize moisture loss.

## Dairy Products & Eggs

- Most dairy products have their best-before date on the outer packaging which informs the recommended temperature and shelf life of the foods.
- Eggs should be stored in the Egg pocket.

## Meats / Fish / Poultry

- Place on a plate or a dish and cover with paper or plastic wrap.
- For larger cuts of meat, fish, or poultry, place to the rear of the shelves.
- Ensure all cooked food is wrapped securely or placed in an airtight container.

## For best freezing

- Quality of foods should be fresh.
- Freeze small quantities of food at a time in order to freeze them quickly.
- Food should be properly sealed or covered tightly.
- Place foods in the freezer evenly.
- Label bags or containers to keep an inventory of freezing food.

### \*Notes for fresh food

- Fresh food (securely wrapped) should be stored in limited time to prevent spoilage and badly affecting other stored foods.

## Tips for saving energy

- Install the refrigerator in a well-ventilated area and keep the space to ventilate.
- The amount of energy consumption of this model is measured as shown in the picture below.

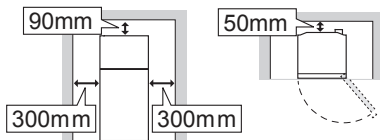

- Keep your refrigerator out of direct sunlight, and do not place it next to heat generating appliance.
- Avoid opening the door as much as possible.
- Hot foods should be cooled before storing.
- Place the food evenly on the shelves to allow the cool air to circulate efficiently.

## Advice for preventing dew or frost inside the refrigerator

- Keep the door securely closed. If the food falls down, it may cause a gap between the cabinet and the door. Move it back to the shelf or the pocket.
- Food with high-moisture should be stored in airtight container or sealed tightly.

## Advice for storing food

- Evenly place the food on the shelves to allow the cooling air to circulate efficiently.
- Opening the door for long periods can cause a significant increase of the temperature in the compartments of the appliance.
- Hot foods should be cooled before storing. Storing hot foods increases the temperature in the unit and the risk of food spoilage.
- Do not block the outlet and inlet of the cool air circulating circuit with foods or containers; otherwise the foods is not be evenly cooled throughout the refrigerator.
- Do not place food directly in front of cold air outlet. This may lead to the food freezing, air to circulate efficiently.

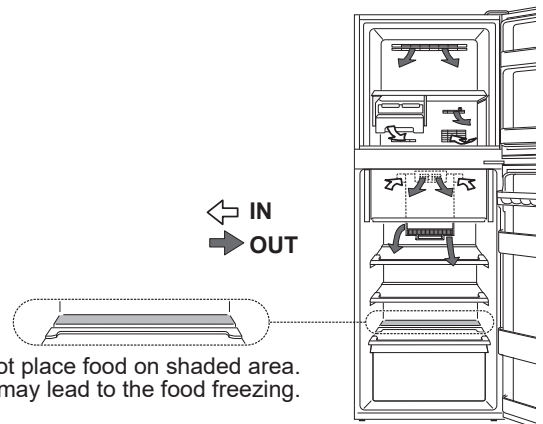

Do not place food on shaded area. This may lead to the food freezing.

Do not place food directly in front of cold air outlet. This may lead to the food freezing.



# Care and cleaning

## Important

Follow the tips below to prevent cracks on the inner surfaces and plastic components

- Wipe out food oil adhered to plastic parts.
- Some household chemicals may cause damage, so use only diluted washing-up liquid (soapy water).
- If undiluted detergent is used or soapy water is not wiped off thoroughly, it may result in cracks of plastic parts.

## Cleaning

For hygienic reasons, make sure to do following things regularly.

- Remove the accessories (e.g. shelves) from the cabinet and the door. Wash them by warm soapy dishwashing water. After that, rinse them in clean water and dry.
- Clean the inside with a cloth soaked in warm soapy dishwashing water. Then, use cold water to wipe off soapy water thoroughly.
- Wipe the exterior with a soft cloth each time it gets dirty.
- Clean the Magnetic door seal with a toothbrush and warm soapy dishwashing water.

## Note

- After cleaning, make sure to put the shelves and the cases on original position.
- Do not use heavy-duty cleansers or solvents (lacquer, paint, polishing powder, benzine, boiled water, etc.) which may cause damages.
- If you pull out the power plug once, wait 5 minutes at least before connecting the power plug again.
- The glass shelves are heavy to carry. Hold them firmly when you remove the shelves from the cabinet.
- Do not drop objects inside the refrigerator or strike the inner wall. This may cause cracks to inner surface.

## Defrosting

Defrosting is automatically operated by a unique energy saving system.

## When the compartment light is blown

Contact the service agent approved by SHARP to replace the light. The light is not to be replaced other than by qualified service personnel.

## Switching off your refrigerator

If the refrigerator needs to be switched off for an extended period, the following steps should be taken to reduce the growth of mold:

1. Remove all food.
2. Remove the power plug from the socket.
3. Clean and dry the interior thoroughly.
4. Keep all the doors open slightly for a few days to dry.

# Before you call for service

Before calling for service, check the following points.

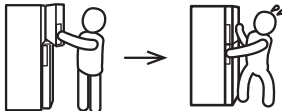
Problem	Solution
The outside of the cabinet is hot when touching.	It is normal. The hot pipe is in the cabinet in order to prevent dew generation.
When there is refrigerator noise.	<p>It is normal for the refrigerator to make the following sounds.</p> <ul style="list-style-type: none"> <li>• Loud noise is made by the compressor when its operation starts               <ul style="list-style-type: none"> <li>-- Sound becomes quieter after a while.</li> </ul> </li> <li>• The compressor makes loud noise once a day.               <ul style="list-style-type: none"> <li>-- Operating sound is made immediately after automatic defrost operation.</li> </ul> </li> <li>• Sound of flowing fluid (gurgling sound, fizzing sound)               <ul style="list-style-type: none"> <li>-- Sound of refrigerant flowing in pipes (sound may become louder from time to time).</li> </ul> </li> <li>• Cracking or crunching sound, squeaking sound               <ul style="list-style-type: none"> <li>-- Sound produced by expansion and contraction of inner walls and internal parts during cooling.</li> </ul> </li> </ul>
Frost or dew appears inside or outside the refrigerator.	<p>This may occur in one of the following cases. Use a wet cloth for wiping frost and a dry cloth for wiping dew.</p> <ul style="list-style-type: none"> <li>• When the ambient humidity is high.</li> <li>• When the door is frequently opened and closed.</li> <li>• When foods containing plenty of moisture are stored. (Wrapping is required.)</li> </ul>
The foods in the refrigerator compartment freeze.	<ul style="list-style-type: none"> <li>• Is the refrigerator operated for a long time with the temp. control knob set COLDEST?               <ul style="list-style-type: none"> <li>-- Change the temperature control to the other setting.</li> </ul> </li> <li>• If ambient temperature is low, foods may freeze even if the the temp. control knob is set at leftmost position.</li> </ul>
Odors in the compartment.	<ul style="list-style-type: none"> <li>• Wrapping is required for the foods with strong odors.</li> <li>• Deodorizing unit cannot remove all odors.</li> </ul>
The refrigerator door is hard to open.	<p>The refrigerator door may become hard to open right after closing the freezer door, because the air temperature and the pressure inside the refrigerator compartment go down.</p> <p>Please wait for approximately 10-15 seconds to open the refrigerator door.</p> 

## If you still require service

Refer to your nearest service agent approved by SHARP.



感謝您購買 SHARP 產品。在使用 SHARP 雪櫃之前，為使您能夠充分使用您所購買的雪櫃，請仔細閱讀本使用說明書。

- 本雪櫃可用於製作冰塊、冷藏和冷凍食物。
- 本雪櫃僅供家庭使用，使用雪櫃的環境溫度已在表格中寫明。氣候類型已在標牌上詳細說明。如果雪櫃在該型號所定的氣候類型範圍（環境溫度範圍）外運作，可能無法維持符合要求的內部溫度。如在較冷的溫度下使用本雪櫃，則溫度在+5°C以內不會損壞雪櫃。
- 雪櫃在一段長時間內不應受到-10°C或以下的溫度。

僅限於家庭用途

氣候類型	可接受的環境溫度範圍
SN	+10°C ~ 32°C
N	+16°C ~ 32°C
ST	+16°C ~ 38°C
T	+16°C ~ 43°C

## 安全注意事項

 <b>警告</b>	這表明導致死亡或重傷的風險很高。
 <b>注意</b>	這表明導致材料受損或人員受傷的風險很高。
 <b>注意</b>	火災標誌表示該雪櫃存在火災事故的風險。

### 警告

#### 冷媒種類

本雪櫃含有易燃冷媒（R600a：異丁烷）和絕熱發泡氣體（環戊烷）。  
為防止著火和爆炸，請遵守以下規則。

- 不要讓任何尖狀物體接觸製冷系統。雪櫃後側及內部的製冷系統含有冷媒。
- 請勿使用機械設備或其他方式來加速除霜過程。（此雪櫃已採用自動除霜系統。）
- 請勿在雪櫃內使用電器。
- 請勿堵塞雪櫃周圍的空間。
- 請勿在雪櫃附近使用易燃性噴霧劑，例如噴漆，否則可能會導致爆炸或火災。
- 如果雪櫃的冷卻系統出現故障，請勿接觸牆壁電源插座，也勿使用明火。  
開啟窗戶，保持空氣流通。然後聯繫 SHARP 認可的售後服務中心進行維修。

#### 電源線，插頭，插座

為防止觸電或火災，請仔細閱讀以下規則。

- 確保在安裝或移動過程中保護電源纜線不受損壞。  
如果電源插頭或電源線出現鬆動等情況，請勿插入電源插頭。
- 請勿在雪櫃後部放置多個移動式插座或移動式電源供應器。
- 直接將電源插頭牢牢地插入牆壁電源插座。請勿使用延長的電線或轉換插頭。
- 將電源插頭插入符合額定電壓要求的插座上。
- 正確地將接地棒連接到接地端子。
- 請勿用濕手接觸電源插頭。
- 拔出電源插頭時，應該拿住插頭端拔出。  
請不要只拉住電源線。
- 電源插頭上積滿灰塵可能引起火災。  
因此，請時常將其擦淨。

- 雪櫃如果長時間不使用，請將插頭拔出。
- 若可彎曲纜線損壞，必須由 SHARP 批准的服務代理人更換纜線。

#### 安裝

- 請勿將雪櫃設置在濕氣多及濺得到水的地方。這樣會因絕緣失效而導致漏電。而且有時會在雪櫃外側結露。
- 將雪櫃穩妥地安裝在地板的水平位置上。
- 保持通風通暢。

#### 使用中

- 請勿儲藏揮發性物質和易燃性物質，如乙醚、汽油、丙烷氣、氣霧劑罐、粘合劑、純乙醇等。此類物質容易爆炸。
- 請勿在雪櫃內儲存溫度敏感型產品，例如醫藥產品。否則產品極可能會變質。
- 請勿嘗試變更或改裝本雪櫃。  
這可能導致火災、觸電或受傷。
- 請勿將瓶裝或罐裝飲料放入冷凍室。
- 請勿在雪櫃頂部放置任何物品。  
如果物品從雪櫃頂部掉落，可能會導致人員受傷。
- 此雪櫃適合 8 歲或以上的兒童使用。在有符合電器使用安全的監督或指導或者瞭解潛在危險的前提下，此雪櫃也適合身體、感官或智力方面有缺陷的殘障人士，或者缺乏相關經驗或知識的人士使用。兒童不得玩耍雪櫃。在無任何監督的情況下，兒童不得對雪櫃進行清潔及使用者保養。

## 保養

- 為了防止觸電，首先拔掉雪櫃的電源插頭。
- 請勿直接將水灑在雪櫃的內部和外部。這樣會導致生鏽及絕緣性能下降。

## 故障

- 如果您聞到有東西燒焦了，則立即拔出電源插頭。然後聯繫 SHARP 認可的售後服務中心進行維修。
- 萬一發生瓦斯洩漏事故，請打開窗戶通風。請勿觸碰雪櫃或電源插座。

## ! 注意

### 運輸

- 安裝或移動雪櫃時，請使用防護墊以防止地板受損。
- 安全搬運雪櫃。  
如果抬起雪櫃的方式不當，可能會導致人員受傷。

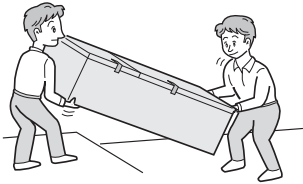

- 搬運雪櫃時請勿握住雪櫃門。



- 在安裝或移動雪櫃前，請確保先聯絡特約維修中心。

## 廢舊雪櫃的處理

- 確保雪櫃在存放時不會對兒童造成危險，直致丟棄為止。（例如，卸下雪櫃門環，防止兒童陷入困境。）
- 應妥善處置本雪櫃。請將雪櫃運送至專業的易燃冷媒及絕熱發泡氣體回收廠。

### 使用中

- 由於壓縮機單元或者其外圍部件在操作過程中將變得非常燙手，千萬不要去觸摸，否則，將會被金屬邊緣燙傷。
- 不要用濕手去觸摸冷凍室內的食物和金屬製容器。恐會導致手凍傷。
- 請勿用飲用水以外的水製作冰塊。
- 請勿將瓶裝或罐裝飲料放入冷凍室。
- 在有人將手放在雪櫃門附近時，請勿開關門。存在其他人可能會被雪櫃門夾住手指的風險。
- 請勿在雪櫃門的雪櫃盒上放置尺寸過大的物品。如果該物品從雪櫃盒上掉落，可能會導致人員受傷。
- 確保在安裝或拆除玻璃層架時要謹慎處理玻璃層架。如果您放下玻璃層架，它可能會破裂或造成傷害。

- 1** 雪櫃的周圍應確保足夠的通風空間。  
此圖顯示了安裝雪櫃所需的最小空間。在不同的空間尺寸下進行能源消耗測量條件。

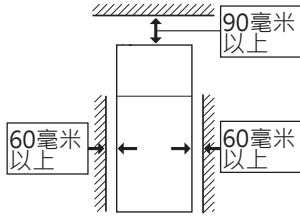

## 後部淨空

雪櫃後部與牆體之間的空間距離應大於 50 毫米且小於 75 毫米。若此空間大於 75 毫米，切勿觸摸在運行中過熱的壓縮機及其外圍零件，以免受傷。

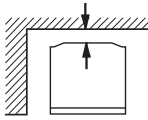

## 請注意

- 雪櫃周圍的空間越大，雪櫃運行時的耗電量越小。
- 如果在小於如圖所示的空間尺寸中使用雪櫃，可能會導致裝置溫度升高、噪音大及故障。
- 請勿將雪櫃靠牆推。雪櫃周圍的牆壁可能會因熱輻射引起的氣流而變髒或變色。

## 使用時所需總體空間

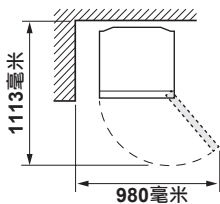

- 2** 請利用調整腳，將雪櫃平穩地放在地板上。

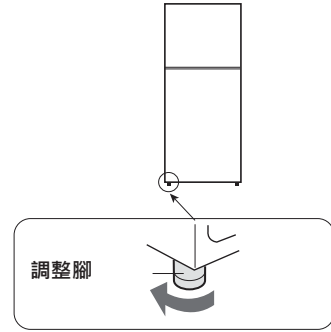

## 請注意

- 設置雪櫃時要充分考慮便於插拔插銷。
- 請勿將雪櫃放在陽光直射的地方或發熱機器的旁邊。
- 請勿把運輸材料用作支架。  
把雪櫃放在堅硬的地板上，而不是直接放在泥土地板上。  
如果將雪櫃放在泥土地板上，請在雪櫃下方使用合適的底座，如木板。

## 在使用雪櫃前

- 用溫水浸泡過的軟布清潔雪櫃內部。  
如果使用肥皂水，請用水徹底擦拭乾淨。
- 拆卸包裝材料（襯墊、藍色膠帶等）。

# 各部位名稱

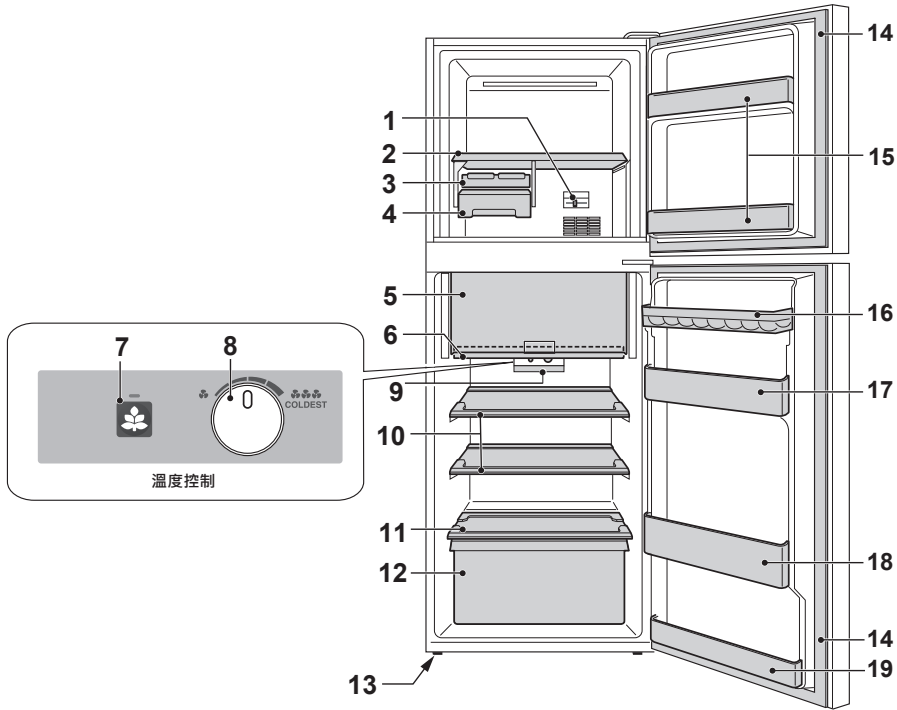

1. 溫度控制桿
2. 冷凍室盤架
3. 的製冰機

- 1) 請勿在冰格中裝滿水。否則，製成的冰會連結在一起。
- 2) 冰製成以後，請按順時針方向轉動控制桿，將冰倒進儲冰盒內。

4. 儲冰盒
5. 兩用冰溫室門
6. 保鮮室盤架

請注意  
為了防止儲冰盒受損，請勿在其中倒入油或用於製冰。

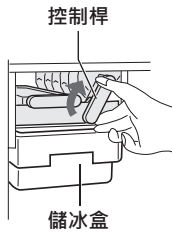

7. 節約能源按鈕
8. 溫度控制旋鈕
9. LED 指示燈
10. 冷藏室盤架
11. 蔬果盤架
12. 蔬果盒
13. 調整腳
14. 門環
15. 冷凍室門盒
16. 蛋盒
17. 冷藏室門盒
18. 瓶盒
19. 小物品架

## 脫臭裝置

已經將脫臭觸媒設置在冷氣的通道上。不需要進行操作和清潔。

## 如果想要在雪櫃內儲存大型物品

- 您可能要卸下上圖中編號 2、3、4、6、10、11、12、15、16、17、18、19 的任何盤架或任何雪櫃盒。
- 本機型的能耗是按照國際標準測量而得，不計製冰機和儲冰盒的能耗。



## 如何打開兩用冰溫室門

- 1) 抬起冰溫室門。
- 2) 將冰溫室門卡入門框中，然後向後推到擋板處。其將正確地鎖定到位。

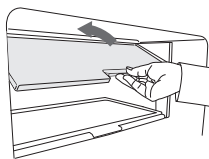

# 實用功能

## 溫度控制旋鈕 (位於冷藏室內)

該旋鈕的預設設定如下圖所示。該旋鈕的作用是根據冷藏室的溫度調節製冷系統的冷卻強度。  
當旋鈕轉到「COLDEST」側時，兩個儲藏室（冷藏室和冷凍室）均冷卻良好。



## 溫度控制桿 (位於冷凍室內)

將控制桿調至中間，以供正常使用。  
該控制桿用於開關通向冷藏室的空氣通道。  
當控制桿滑到「COLDEST」側時，只有冷凍室冷卻良好。

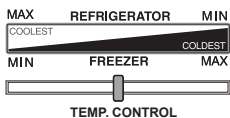

控制桿的位置	條件
左側	<ul style="list-style-type: none"> <li>進入冷藏室的冷氣量更多。</li> <li>冷藏室冷卻良好。</li> </ul>
右側	<ul style="list-style-type: none"> <li>進入冷凍室的冷氣量更多。</li> <li>冷凍室冷卻良好。</li> </ul>

建議的溫度設定如下所示。

	溫度控制桿	溫度控制旋鈕
正常		
在冬季 (低於 10°C)	<ul style="list-style-type: none"> <li>設定在右側。</li> <li>請勿設定在左側。</li> </ul>	

## 節約能源

想將雪櫃切換為節約能源的運轉狀態時，請使用該模式。  
本模式運行時，冷藏室和冷凍室的溫度會高於以下常規操作。

	冷凍室	冷藏室
在“節約能源”模式下	上升大約 3°C	上升大約 4°C

如果覺得飲料不夠冰涼或製冰太費時，可取消此功能。

### 如何啟動操作

按下「節約能源」按鈕。



### 如何取消操作

再次按下「節約能源」按鈕。



### 請注意

- 節能效率取決於使用環境（周圍溫度，開關雪櫃門的頻率，食物總量）。

# 食品的儲存

- 確保食品維持最新鮮的品質，以使易腐食品的保存期限最大化。下列為幫助延長食品儲存的一般指南。
- 食品的儲存時間有限。確保不超過製造商指示的保存期限。

## 水果 / 蔬菜

為儘量減少水分的流失，水果和蔬菜要用保鮮紙及袋子（不封口）之類的塑膠袋輕輕包上，並將其放入蔬果盒內。

## 乳製品和雞蛋

- 幾乎所有乳製品的外包裝上都標有適當的保存溫度和保存期限。
- 請用蛋盒存放雞蛋。

## 肉類 / 魚 / 禽肉

- 請將其放在容器上，並包上保鮮膜。
- 若是大塊的肉、魚或禽肉，請將其放在盤架的後部。
- 已經煮熟的食品務須用保鮮膜包好，或將其放在密封容器內。

## 為達到最佳冷凍效果

- 食品品質應當新鮮。
- 若要快速冷凍食品，每次都必須少量放入。
- 食品應妥善密封或蓋緊。
- 將食品均勻地放入冷凍室。
- 袋子和容器上要標上標示，並寫清楚冷凍食品的內容。

## 針對新鮮食品之注意事項

- 新鮮食品（安全包裝）應儲存有限時間，以防變質並嚴重影響其他儲存的食品。

### 節約能量的竅門

- 把雪櫃安裝在通風良好的地方，並保持通風。
- 此模型的能源消耗量如下圖所示測量。

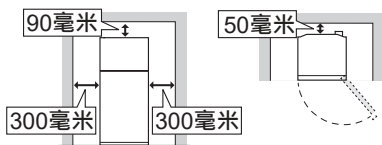

- 請勿將雪櫃放在陽光直射的地方或發熱機器的旁邊。
- 盡量避免開門。
- 請將較熱的食品涼下來以後，才保存起來。
- 為使冷氣充分循環，請將食品均勻地放在盤架上。

## 防止雪櫃內部結水珠或結霜的建議

- 使門緊密關上。如果食品落下，可能導致雪櫃與雪櫃門之前有縫隙。將其放回層架或門盒中。
- 水分含量高的食品應存放在密封容器中或密封保存。

## 建議儲存食物

- 為使冷氣充分循環，請將食品均勻地放在盤架上。
- 雪櫃門長時間開啟可能會造成電器內部空間溫度明顯升高。
- 請將較熱的食品涼下來以後，才保存起來。如果將較熱的食品放進雪櫃，雪櫃內的溫度會升高，這樣往往很容易導致食品腐爛變質。
- 請勿讓食品或容器擋住冷氣循環迴路的出風口和進氣口。否則，食品在雪櫃內就不能均勻地冷卻。
- 請勿直接將食品放在冷氣出風口旁。這樣會引致食品結冰。

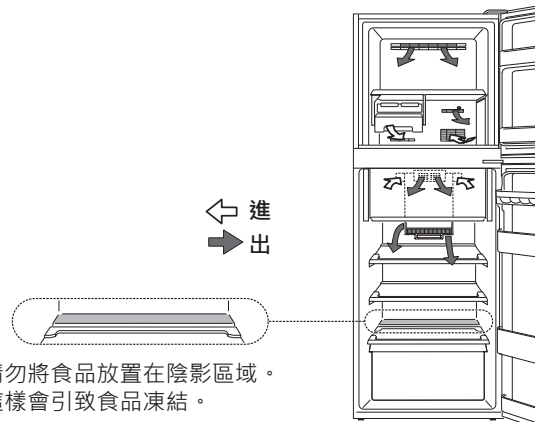



## 重要提示

遵循下面貼士，防止內部表面與塑膠元件出現裂痕

- 食用油沾上塑料部件時，請將之擦掉。
- 某些家用化學洗滌劑可能會導致雪櫃損傷，因而只能使用稀釋過的廚房用洗滌劑（肥皂水）。
- 如果使用未稀釋的洗劑或者未徹底擦淨肥皂水，則有可能損壞雪櫃的塑料部件。

## 清潔

出於衛生理由，請確保定期進行以下操作。

- 拆下雪櫃櫃體和門上的配件（如盤架）。用溫水和廚房用洗滌劑清洗。然後，用水洗清並使之乾透。
- 用浸泡廚房用洗滌劑的溫水中的軟布清潔雪櫃內部。接著使用冷水徹底擦除洗滌水。
- 雪櫃的外殼沾上污漬時，請用柔軟的布塊擦洗。
- 雪櫃門環要用廚房用洗滌劑的溫水和牙刷洗淨。

## 請注意

- 清潔之後，請確保將盤架和收納盒放在原本的位置上。
- 請勿使用強力清潔劑或溶劑（油漆、塗料、拋光粉、汽油、沸水等），否則可能導致雪櫃損傷。
- 巨拔出電源插頭，請等待至少5分鐘之後再重新接通電源。
- 玻璃層架很重，不易搬運。當您從雪櫃拆卸層架時，請牢牢抓住。
- 在雪櫃內請勿使物體掉落，或用物體強烈碰撞內壁。否則可能導致內壁破裂。

## 除霜

本雪櫃透過獨特的節約能源系統，完全實現自動除霜。

## 當冷藏室內燈損壞時

請聯繫 SHARP 認可的售後服務中心更換內燈。非符合資格的維修人員不得更換內燈。

## 切斷雪櫃的電源時

如果雪櫃需要長時間關閉，則應採取以下步驟以減少黴菌生長：

1. 拿出所有食物。
2. 從插座處拔除電源插頭。
3. 徹底清潔並乾燥內部區域。
4. 保持所有雪櫃門稍微開放幾天進行乾燥。

# 送修之前的初步檢查

送修之前，請檢查以下幾點。

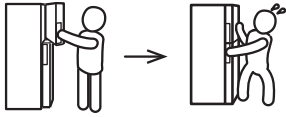
問題	對策
雪櫃櫃體外部摸起來很燙。	這並非異常。熱管位於雪櫃櫃體內，以防止結露。
雪櫃發出噪音時。	雪櫃如發出以下聲音，這並非異常。 <ul style="list-style-type: none"><li>• 壓縮機運轉開始時會發出較大的噪音<ul style="list-style-type: none"><li>-- 不久聲音會變小。</li></ul></li><li>• 壓縮機每日一次發出較大噪音。<ul style="list-style-type: none"><li>-- 在自動除霜作業之後，立即會發出運作聲音。</li></ul></li><li>• 液體流動的聲音（咕嚕聲、嘶嘶聲）<ul style="list-style-type: none"><li>-- 冷媒在管道中流動的聲音（聲音時而會變得較大）。</li></ul></li><li>• 劈啪聲或吱嘎聲，吱吱聲<ul style="list-style-type: none"><li>-- 冷卻時內壁和內部零件膨脹和收縮產生的聲音。</li></ul></li></ul>
雪櫃內部和雪櫃外側結霜或結露。	在下列情形下有可能發生這種現象。請用濕布擦掉霜，用乾布擦掉露珠。 <ul style="list-style-type: none"><li>• 周圍溫度較高時。</li><li>• 頻繁開啟雪櫃門時。</li><li>• 存放水分較多的食品時。（請用保鮮膜包上）</li></ul>
冷藏室內的食品結冰。	<ul style="list-style-type: none"><li>• 是否長期在溫度控制旋鈕設為 COLDEST 的狀態下使用雪櫃？<ul style="list-style-type: none"><li>-- 將溫度調節設定改為其他設定。</li></ul></li><li>• 在環境溫度較低時，即使將溫度控制旋鈕設定為最左側位置，食品也可能會結冰。</li></ul>
雪櫃內部有異味。	<ul style="list-style-type: none"><li>• 請將氣味較強的食品用保鮮紙包起來。</li><li>• 脫臭裝置不能去掉所有異味。</li></ul>
雪櫃門很難打開。	剛關上冷凍室門後，可能難以打開雪櫃門，這是因為冷藏室內的氣溫和壓力會下降。請等待大約 10-15 秒後再打開雪櫃門。 

經檢查後仍需要送修時

請與就近的SHARP認可的售後服務中心洽詢。



# **SHARP**

SHARP CORPORATION