

SHARP



Refrigerant: R600a

Insulation blowing gas: Cyclopentane

冷媒種類 : R600a

絕緣發泡材主要成份 : 環戊烷

香港電器安全規格

(國際電工委員會規格適合)

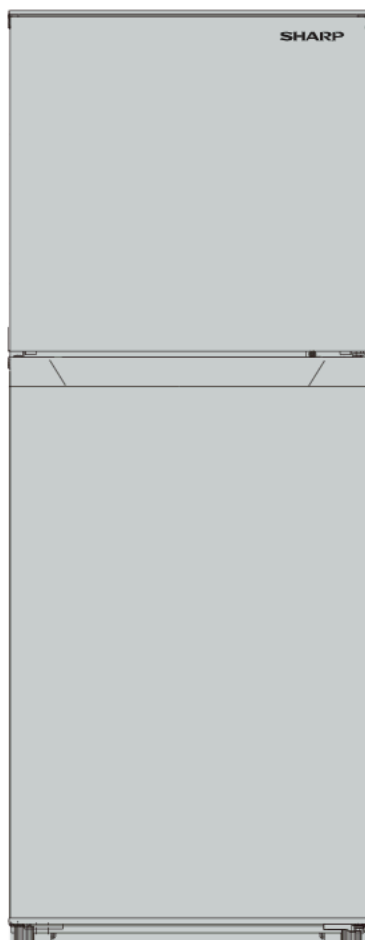

SJ-T19M-G

Refrigerator - Freezer Operation manual

Contents

• Safety information	2
• Installation.....	4
• Part names	5
• Controlling temperature.....	6
• Storing food	7
• Care and cleaning.....	8

原裝進口雪櫃 使用說明書

目錄



• 安全注意事項	9
• 安裝	11
• 各部位名稱	12
• 溫度調節.....	13
• 食品的儲存	14
• 保養	15

Thank you very much for buying this SHARP product. Before using your SHARP refrigerator, please read this operation manual to ensure that you gain the maximum benefit from it.

- This refrigerator is intended for making ice cubes, refrigerating and freezing food.
- This refrigerator is for household use only, with ambient temperature indicated between +5°C and +38°C.
- The refrigerator should not be subjected to temperatures of -10°C or below for a long period of time.

Household use only

Safety information

 Warning	This means that there are high risks of death or serious injury.
 Caution	This means that there are high risks of material damage or personal injury.
 Caution	Fire marks means this refrigerator has risk of fire accident.



Warning

Refrigerant

This refrigerator contains flammable refrigerant (R600a: isobutane) and insulation blowing gas (cyclopentane). Observe the following rules to prevent ignition and explosion.

- Do not damage the refrigerant circuit.
- Do not allow any sharp objects to have contact with the refrigeration system. The refrigeration system behind and inside the refrigerator contains refrigerant. Leaking refrigerant can ignite and may damage the eyes.
- Do not use mechanical devices or other means to accelerate the defrosting process. (This refrigerator has adopted automatic defrosting system.)
- Do not use electrical appliances inside the refrigerator.
- Do not block the space around the refrigerator.
- Do not use flammable sprays, such as spray paint near the refrigerator.
- Do not store flammable sprays, such as spray paint in the refrigerator.
- In the case of failure of the refrigeration system, do not touch the wall socket and use open flames. Open the window and air out the room. Then ask a service agent approved by SHARP for service.

Power cord, Plug, Socket

Read carefully the following rules to prevent electric shock or fire.

- Make sure to protect the power cord from being damaged during installation or moving. If the power plug or cord is loose, do not insert the power plug.
- Do not place multiple portable socket-outlets or portable power supplies at the rear of the refrigerator.
- Connect the power plug into the wall socket firmly and directly. Do not use an extension cord or adapter plug.
- Connect the power plug to the socket with the required rated voltage.
- Connect the earth pin to the earth terminal properly.
- Do not touch the power plug with wet hands.

- Disconnect from the main electricity supply by removing the main plug from the socket. Do not remove by pulling the power cord.
- Dust deposited on the power plug may cause fire. Wipe it off carefully.
- Pull out the plug if the refrigerator is not used for a long time.
- If the flexible supply cord is damaged, it must be replaced by service agent approved by SHARP in order to avoid a hazard.

Installation

- Do not install the refrigerator in a damp or wet location. It may cause the damage to the insulation or electrical leak. Dew may also appear on the outer cabinet and it causes rust.
- The refrigerator should be installed flatly and firmly on the floor.
- Keep ventilation openings.

In use

- Do not store volatile and flammable materials such as ether, petrol, propane gas, aerosol cans, adhesive agents and pure alcohol etc. These materials are easy to explode.
- Do not store temperature-sensitive products such as pharmaceutical products in the refrigerator. There are high risks of changes in product quality.
- Do not attempt to change or modify this refrigerator. This may result in fire, electric shock or injury.
- Do not place a container filled with liquid on the top table.
- Do not place unstable objects on the top table or add significant weight in front of the step.
- This appliance can be used by children aged from 8 years or above and persons with reduced physical, sensory or mental capabilities or lack of experience and knowledge if they have been given supervision or instruction concerning use of the appliance in a safe way or understanding the hazards involved. Children shall not play with the appliance. Cleaning and user maintenance shall not be done by children without supervision.

Care and Cleaning

- Unplug the refrigerator first to prevent electric shock.
- Do not splash water directly on the outer cabinet or the interior. This may lead to rusting and deterioration of the electrical insulation.

Trouble

- If you smell something burnt, pull out the power plug immediately. Then ask a service agent approved by SHARP for service.
- In case of gas leak, ventilate the area by opening window. Do not touch the refrigerator or the power socket.



Caution

Transportation

- When you install or move your refrigerator, use curing mat to protect the floor from being damaged.
- Carry the refrigerator securely. If you lift up the refrigerator improperly, it may cause injury.

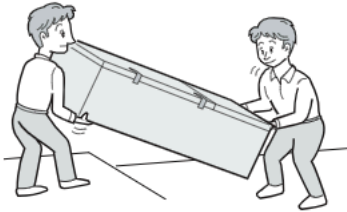

Disposal

- Ensure that the refrigerator presents no danger to children while being stored for disposal. (e.g. remove the magnetic door seals to prevent child entrapment.)
- This refrigerator should be disposed appropriately. Take the refrigerator to a professional recycling plant for flammable refrigerant and insulation blowing gases.

In use

- Do not touch the compressor unit or its peripheral parts, as they become extremely hot during operation and the metal edges may cause injury.
- Do not touch food or metal containers in the freezer compartment with wet hands. This may cause frostbite.
- Do not use other than potable water to make ice cubes.
- Do not place bottled drinks and cans in the freezer compartment as they may crack when frozen.
- Do not open or close the door when other people put a hand near the door. There is a risk that the other people may get their fingers caught in the door.
- Do not put oversized object in the pockets of the door. If the object falls down from the pockets, it may cause injury.
- Make sure to handle the glass shelves with care to install or uninstall. If you drop the glass shelves, it may break or cause injury.

- 1** Keep adequate ventilation space around the refrigerator.
The picture shows the minimum required space for installing the refrigerator. The measurement condition of energy consumption is conducted under a different space dimension.

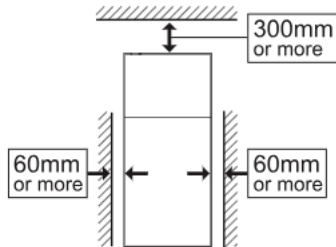

Rear clearance

The space between the rear of the refrigerator and the wall should be 50mm or more, and less than 75mm. If the space is wider than 75mm, you may get injured by touching compressor and its peripheral parts which are extremely hot during the operation.

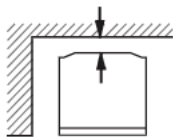

Note

- By keeping greater space, the refrigerator may consume a less amount of power consumption.
- If use the refrigerator in the smaller space dimension than figured, it may cause temperature rise in the unit, loud noise and failure.
- Do not push the refrigerator against the wall. The wall surrounding the refrigerator may get dirty or discolored because of the air flow caused by heat radiation.

Overall space required in use

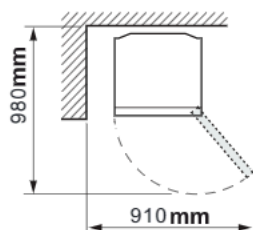

Make sure that there is enough space for the doors to open fully. Otherwise, you may not be able to slide the shelves or drawers completely.

How to install the refrigerator

Use adjustable feet (2 places) to stable the refrigerator for preventing noise and vibration.

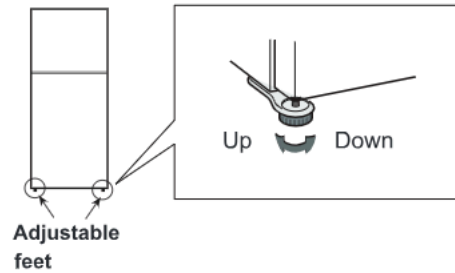

1. Lift up the bottom of the refrigerator slightly and turn the adjustable feet.
2. Down the refrigerator straight and check following points.
 - Are adjustable feet reach to the floor?
 - Is the refrigerator stabled?
 - Is the refrigerator put vertically?

Note

- Place your refrigerator to access the plug.
- Keep your refrigerator out of direct sunlight and do not place next to heat generating appliance.

Before using your refrigerator

Clean the inside parts with a cloth soaked in warm water. If soapy water is used, wipe it off thoroughly with water.

Part names

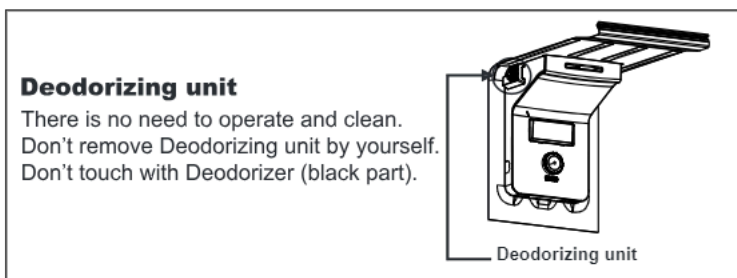
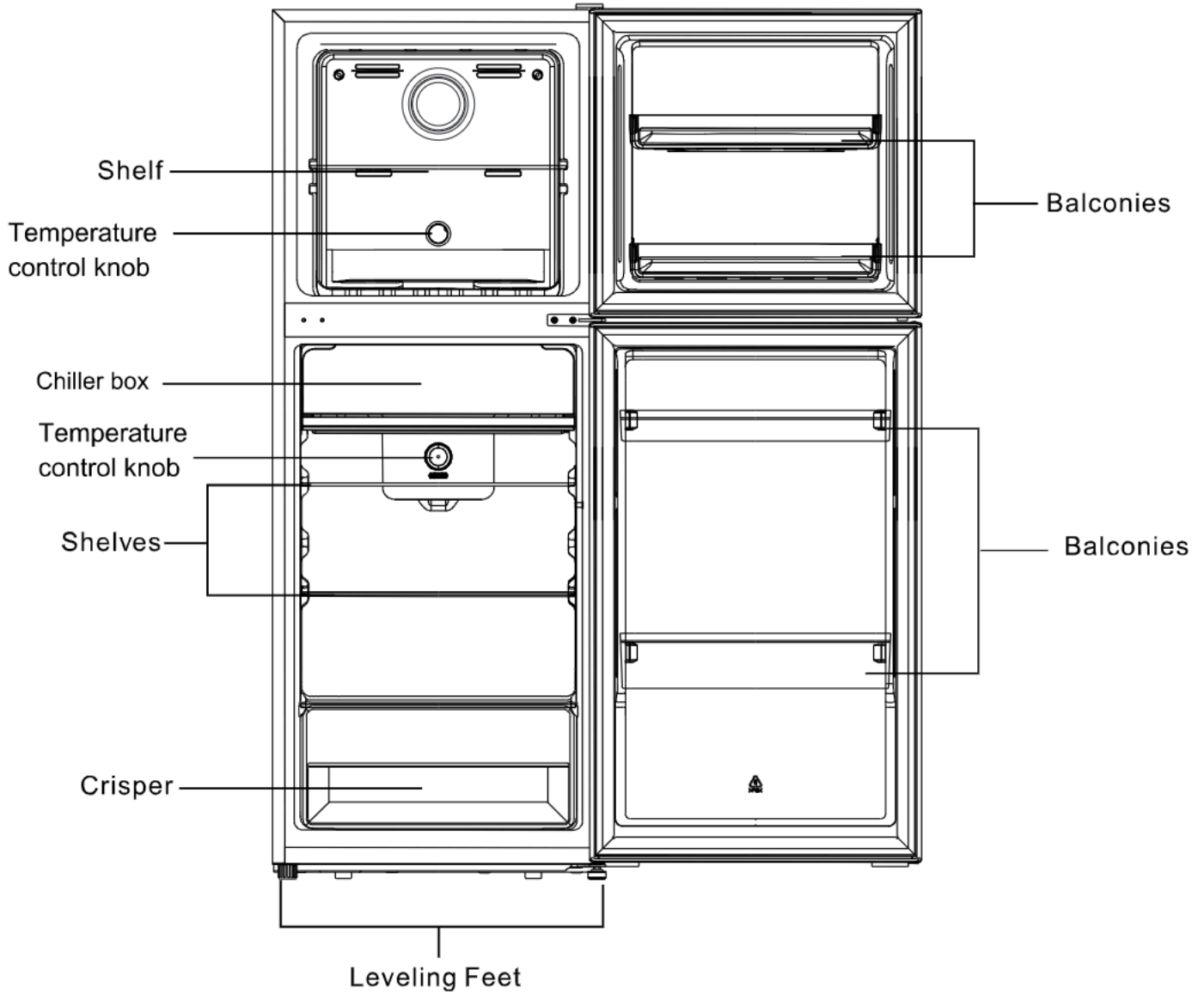

Note: Above picture is for reference only. The actual appliance maybe slightly different.

Controlling temperature

Using the Control Panel

Freezer compartment Temperature Setting

- Plug on your appliance. The internal temperature is controlled by a sensor. There are 3 settings: SUMMER, RECOMMENDED and WINTER.
- The appliance may not operate at the correct temperature if it is in a particularly hot or if you open the door often.

Important!

Usually we advise the user set the temperature control knob at "NORMAL" or "RECOMMENDED".

Set the temperature control knob at "SUMMER" in summer or hot days.

If the ambient temperature is very high (above 43°C), consider adjusting it to the dotted line on the left.

Set the temperature control knob at "WINTER" in winter or cold days.

If the ambient temperature is very low (below 10°C), consider adjusting it to the dotted line on the right.

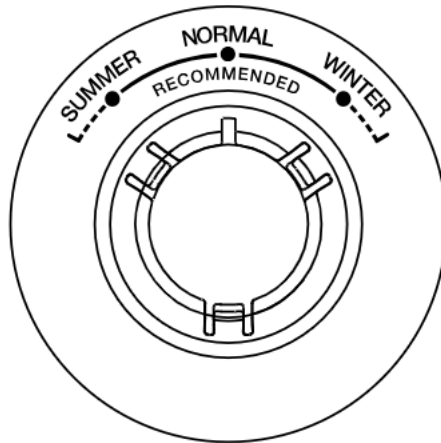

Fridge compartment Temperature Setting

- Plug on your appliance. The internal temperature is controlled by a sensor. There are 8 settings: 0,1,2,3,4,5,6,7. 1 is warmest setting and 7 is coldest setting,0 is off.
- The appliance may not operate at the correct temperature if it is in a particularly hot or if you open the door often.
- Neither fridge or freezer compartment works when the setting is OFF.

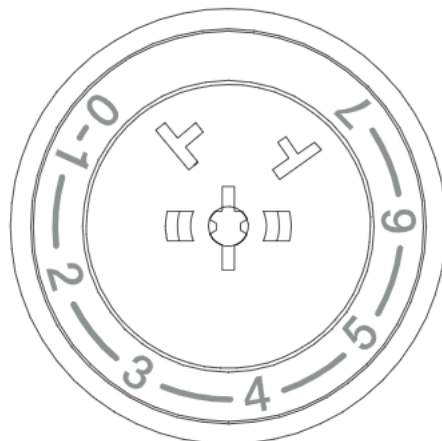

Storing food

Refrigeration reduces the rate of food spoilage. Ensure that the food is of the freshest possible quality to maximize the shelf life of perishable food. The following is a general guide to help promote longer food storage.

Fruit / Vegetables

Fruit and vegetables should be loosely enclosed in a plastic material e.g. wrap, bags (do not seal) and placed in the vegetable crisper to minimize moisture loss.

Dairy Products & Eggs

- Most dairy products have their best-before date on the outer packaging which informs the recommended temperature and shelf life of the food.
- Eggs should be stored in the Egg tray.

Meat / Fish / Poultry

- Place on a plate or a dish and cover with paper or plastic wrap.
- For larger cuts of meat, fish, or poultry, place to the rear of the shelves.
- Ensure all cooked food is wrapped securely or placed in an airtight container.

* Notes for fresh food:

- Fresh food (securely wrapped) should be stored in limited time to prevent spoilage and badly affecting other stored foods.

For best freezing

- Quality of food should be fresh.
- Freeze small quantities of food at a time in order to freeze them quickly.
- Food should be properly sealed or covered tightly.
- Place food in the freezer evenly.
- Label bags or containers to keep an inventory of freezing food.

Advice for preventing dew or frost inside the refrigerator

- Make sure to put the food on the shelf or in the pocket. If the food falls down, the door is not closed securely.
- Food with high-moisture should be stored in airtight container or sealed tightly.

Note

- Place the food evenly on the shelves to allow the cooling air to circulate efficiently.
- Hot food should be cooled before storing. Storing hot food increases the temperature in the unit and the risk of food spoilage.
- Opening the door for long periods can cause a significant increase of the temperature in the compartments of the appliance.
- Do not block the outlet and inlet of the cool air circulating circuit with food or containers; otherwise the food can not be evenly cooled throughout the refrigerator.

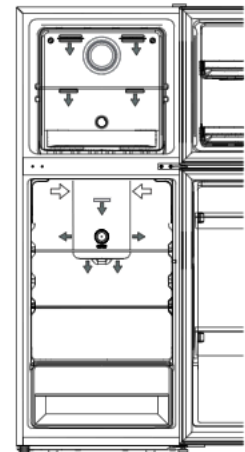

Do not place food directly in front of cold air outlet. This may lead to the food freezing.

Care and cleaning

Important

To prevent cracks on inside surfaces and plastic components, follow these tips.

- Wipe out food oil adhered to plastic parts.
- Some household chemicals may cause damage, so use only diluted washing-up liquid (soapy water).
- If undiluted detergent is used or soapy water is not wiped off thoroughly, it may result in cracks of plastic parts.

Cleaning

- Remove the accessories (e.g. shelves) from the cabinet and the door. Wash them by warm soapy dishwashing water. After that, rinse them in clean water and dry.
- Clean the inside with a cloth soaked in warm soapy dishwashing water. Then, use cold water to wipe off soapy water thoroughly.
- Wipe the exterior with a soft cloth each time it gets dirty.
- Clean the Magnetic door seal with a toothbrush and warm soapy dishwashing water.

Note

- Do not use heavy-duty cleansers or solvents (lacquer, paint, polishing powder, benzine, boiled water, etc.) which may cause damages.
- If you pull out the power plug once, wait 6 minutes at least before connecting the power plug again.
- Do not drop objects inside the refrigerator or strike the inner wall. This may cause cracks to inner surface.
- Make sure not to drop the glass shelves when you remove them from the cabinet.

Defrosting

Frost on the cooling equipment (hidden from the outside) is melted regularly and fall into the evaporating pan. After that, the water is dried up by the heat of compressor.

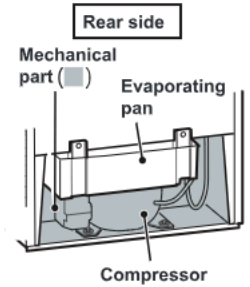

When the compartment light is blown

Contact the service agent approved by SHARP to replace the light. The light is not to be replaced other than by qualified service personnel.

Switching off your refrigerator

If the refrigerator needs to be switched off for an extended period, the following steps should be taken to reduce the growth of mold:



1. Remove all food.
2. Remove the power plug from the socket.
3. Clean and dry the interior thoroughly.
4. Keep all the doors open slightly for a few days to dry.

感謝您購買 SHARP 產品。在使用 SHARP 雪櫃之前，為使您能夠充份使用您所購買的雪櫃，請仔細閱讀本使用說明書。

- 本雪櫃可用於製作冰塊、冷藏和冷凍食物。
- 這個雪櫃僅限於家庭用途，使用雪櫃的環境溫度為 +5°C 和 +38°C 之間。
- 雪櫃在一段長時間內不應受到 -10°C 或以下的溫度。

僅限於家庭用途

安全注意事項

 警告	這表明導致死亡或重傷的風險很高。
 安全注意事項	這表明導致材料受損或人員受傷的風險很高。
 安全注意事項	火焰標誌表示此裝置有發生火災事故的風險。



警告

冷媒

雪櫃含有易燃製冷劑（R600a：異丁烷）和絕熱發泡氣體（環戊烷）。為防止著火和爆炸，請遵守以下規則。

- 請勿破壞製冷回路。
- 雪櫃內部及後側的製冷系統內含有製冷劑。請務必避免任何尖銳的物體碰觸製冷系統。洩漏的製冷劑會著火且可能傷害眼睛。
- 請勿使用機械設備或其他方式來加速除霜過程。（此雪櫃已採用自動除霜系統）
- 請勿在雪櫃內使用電器。
- 請勿堵塞雪櫃周圍的空間。
- 請勿在雪櫃附近使用易燃性噴霧劑，例如噴漆，否則可能會導致爆炸或火災。
- 請勿在雪櫃附近儲藏如噴漆等易燃性噴霧罐。
- 如果雪櫃的冷卻系統上有損毀，請勿接觸牆壁電源插座，也勿使用明火。打開窗戶，使房間空氣流通。然後聯繫 SHARP 認可的售後服務中心進行維修。

電源線，插頭，插座

為防止觸電或火災，請仔細閱讀以下規則。

- 在安裝或移動的過程中，請確保電源線完好無損。如果電源插頭或電源線出現鬆動等情況，請勿插入電源插頭。
- 請勿在雪櫃後部放置多個移動式插座或移動電源。
- 直接將電源插頭插入牆壁電源插座。請勿使用延長的電線或轉換插頭。
- 將電源插頭插入符合額定電壓要求的插座上。
- 正確地將接地線連接到接地端子。
- 請勿用濕手接觸電源插頭。

- 拔出電源插頭時，請不要只拉住電源線，應該拿住插頭端拔出。
- 電源插頭上積滿灰塵是引起火災的原因。因此，請時常將其擦淨。
- 雪櫃如果長時間不使用，請將插頭拔出。
- 電源線損壞時，請到 SHARP 認可的售後服務中心更換，以免造成危險。

安裝

- 請勿將雪櫃設置在潮濕的地方。這樣會因絕緣失效而導致漏電。而且有時會在雪櫃外側結露。
- 將雪櫃穩妥地安裝在地板的水平位置上。
- 保持通風通暢。

使用中

- 請勿儲藏揮發性物質和易燃性物質，如乙醚、汽油、丙烷氧、粘合劑、純乙醇等。此類物質有爆炸之危險。
- 請勿在雪櫃內儲存溫度敏感型產品，例如醫藥產品。否則產品極可能會變質。
- 請勿改裝雪櫃。修理技術人員以外的人員拆卸和修理本機，會導致火災、觸電和受傷。
- 請勿將裝有液體的容器置於機頂表面上。
- 請勿將不穩定的物體置放在機頂表面上或在間隙前增加額外重量。
- 此雪櫃適合 8 歲及以上的兒童使用。在有符合電器使用安全的監督或指導及了解潛在危險的前提下，此雪櫃也適合身體、感官或智力方面有缺陷的殘障人士、或者缺乏相關經驗或知識的人士使用。禁止讓兒童玩弄雪櫃。在無任何監督的情況下，兒童不得對雪櫃進行清潔及維修保養。

保養

- 為了防止觸電，首先拔掉雪櫃的電源插頭。
- 請勿直接將水灑在雪櫃的內部和外部。這樣會導致生銹及絕緣性能下降。

故障

- 如果聞到燒焦的味道，請立即拔出電源插頭，然後聯繫 SHARP 認可的售後服務中心進行維修。
- 如果發生煤氣洩漏，請開窗通風，切勿觸摸雪櫃和電源插座。



安全注意事項

運輸

- 安裝或移動雪櫃時，請使用防護墊以防止地板受損。
- 請妥善搬運雪櫃。如果抬起雪櫃的方式不當，可能會導致人員受傷。

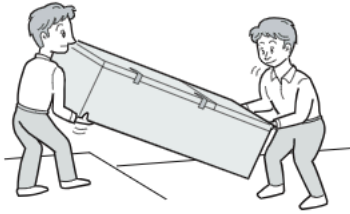

廢舊雪櫃的處理

- 確保雪櫃在等候處理的過程中不會給兒童造成危險。（例如拆除門封條以防兒童不慎夾住。）
- 請妥善處理，將雪櫃運送至專業的可燃性製冷劑及絕熱發泡氣體廢料處理廠。

使用中

- 由於壓縮機或者其外圍部件在操作過程中將變得非常燙手，千萬不要觸摸，否則，將會被金屬邊緣燙傷。
- 不要用濕手觸摸冷凍室內的食品和金屬製容器，這可能會導致凍傷。
- 僅能使用飲用水製冰。
- 請勿將瓶裝或罐裝飲料放入冷凍室。
- 當其他人的手靠近雪櫃門時，請勿打開或關閉雪櫃門，否則雪櫃門會夾住手指。
- 請勿在雪櫃門架上放置尺寸過大的物品。如果該物品從雪櫃門架上掉落，可能會導致受傷。
- 安裝或拆下時，請確定小心處理玻璃層架。若玻璃層架不慎摔落，它可能會破裂或導致受傷。

- 1** 雪櫃的周圍應確保足夠的通風空間。圖中顯示出安裝雪櫃所需要的最低限度的空間。耗電量的測試需在不同空間條件下進行。

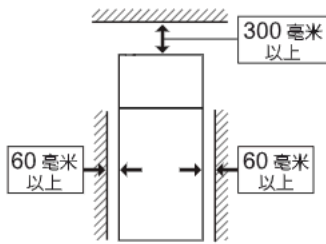

雪櫃後方間隙

雪櫃後部與牆壁之間的空間距離應為大於 50 毫米且小於 75 毫米。若此空間大於 75 毫米，切勿觸摸在運行中過熱的壓縮機以及外圍部件，以免受傷。

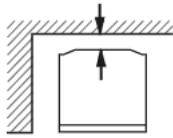

請注意

- 雪櫃周圍的空間越大，雪櫃運行時的耗電量越小。
- 若在小於以下圖所示尺寸的空間內使用雪櫃，可能會導致裝置溫度升高，噪音加大和其他故障。
- 請勿將雪櫃往牆的方向推。雪櫃周圍的牆壁會因熱輻射產生的氣流而變髒或褪色。

使用時所需總體空間

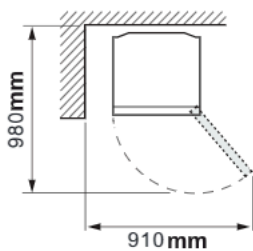

為了讓門可以完全打開，請確保有足夠的空間。否則，你可能無法完全滑動層架或抽屜。

如何安裝雪櫃

使用調節腳（2 處）穩定雪櫃以防止噪音和振動。

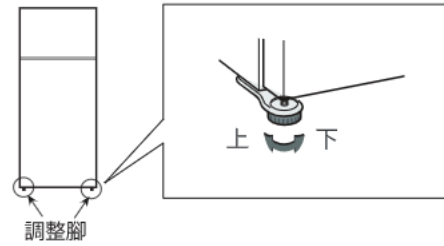

1. 輕輕抬起雪櫃底部並轉動調節腳。
2. 垂直放下雪櫃並檢查下列幾點。
 - 調整腳是否觸及地面？
 - 雪櫃是否穩定？
 - 雪櫃是否垂直放置？

請注意

- 擺放雪櫃時，應考慮靠近電源插頭的位置。
- 請勿將雪櫃放置在陽光直射的地方或發熱機器的旁邊。

在使用雪櫃前

用溫水浸泡過的軟布清潔雪櫃內部。如果使用肥皂液，請用水徹底擦拭乾淨。

各部位名稱

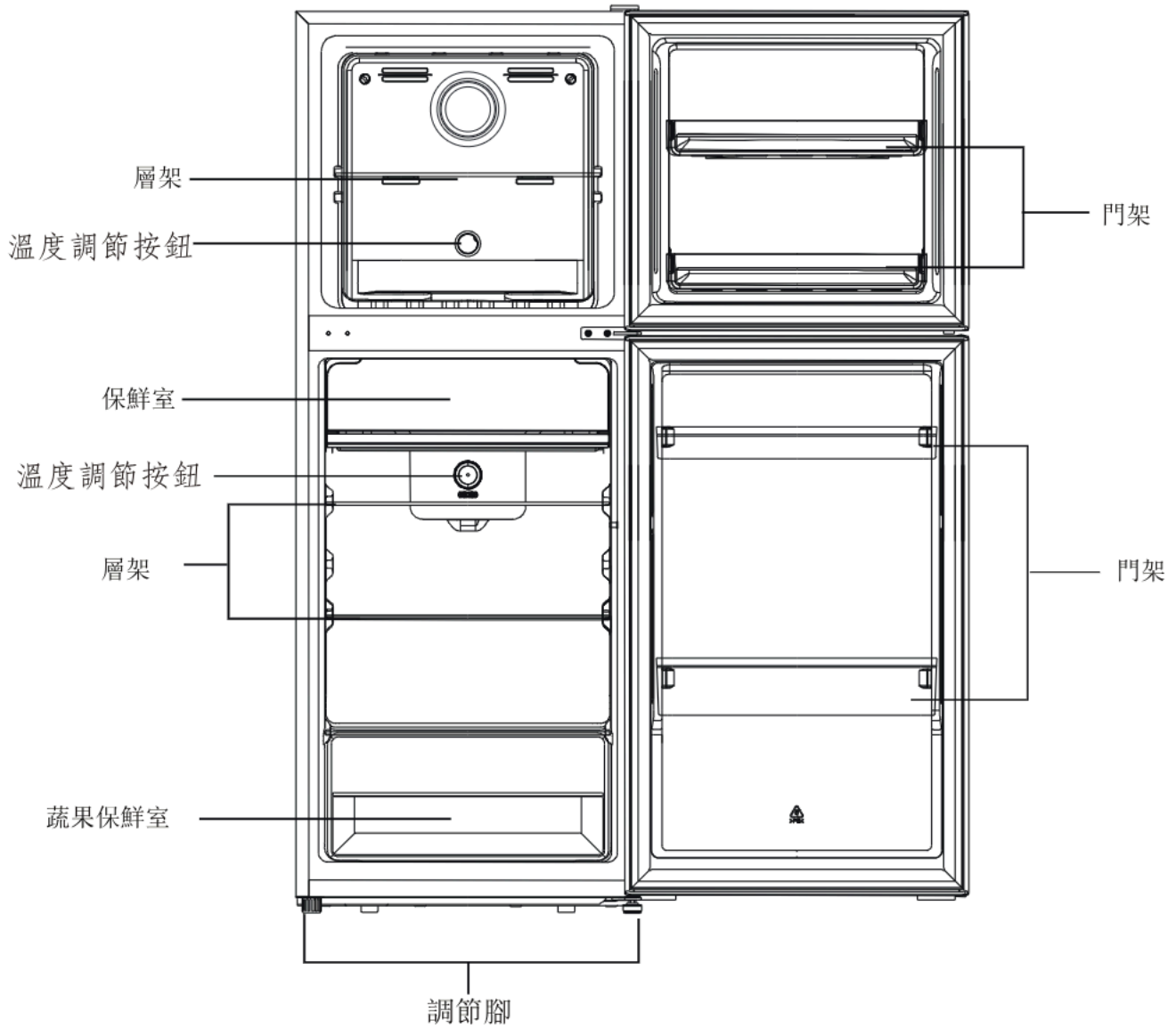

除臭裝置

無需操作和清潔。
請勿自行拆解除臭裝置。
請勿接觸除臭劑(黑色部分)。

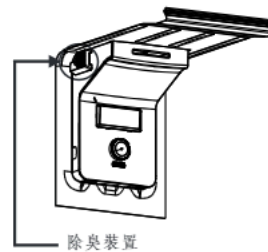

請注意：上圖僅供參考。實際設備可能略有不同。

溫度調節

使用溫度調節旋鈕

冷凍室溫度設定

- 內部溫度由感測器控制。有3個設定：“SUMMER”、“RECOMENDED”和“WINTER”。
- 如果產品特別熱或經常開門，則產品可能無法在正確的溫度下運作。

重要的!

通常我們建議使用者將溫度控制旋鈕設定為“NORMAL”或“RECOMENDED”。

夏季或炎熱天氣時，將溫度控制旋鈕設定為“SUMMER”。

如果環境溫度很高(43℃以上)，可以考慮調整到左邊的虛線。

在冬季或寒冷的日子，將溫度控制旋鈕設定為“WINTER”。

如果環境溫度很低(10℃以下)，可以考慮調整到右側虛線。

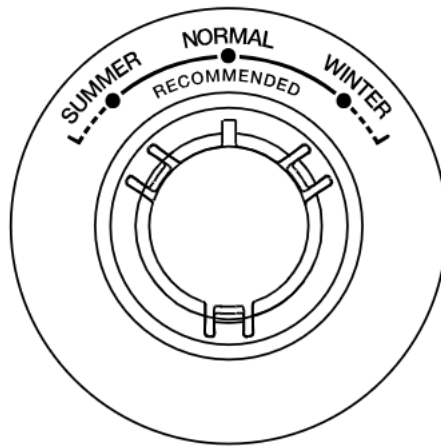

冷藏室溫度設定

• 內部溫度由感測器控制。

有8個設定: 0、1、2、3、4、5、6、7。

1是最熱設置, 7是最冷設置, 0是關閉。

- 如果天氣特別熱或經常開門，則產品可能無法在正確的溫度下運作。
- 設定為「關閉」時，冷藏室或冷凍室均不工作。

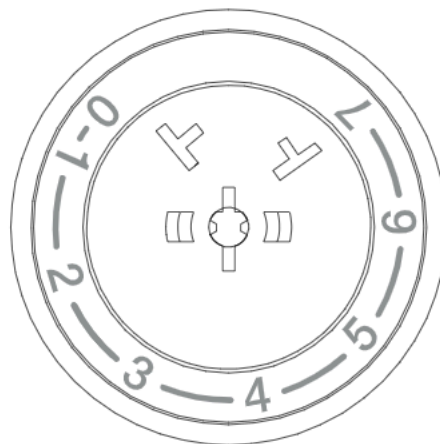

食品儲存

冷藏可以降低食品變質的速度。
確保食物新鮮，以下是幫助延長食物儲存時間的指南。

水果／蔬菜

為盡量減少水份的流失，水果和蔬菜應用保鮮紙及膠袋包裹（不封口），並將其放入蔬果保鮮室內。

乳製品和雞蛋

- 大多數乳製品的包裝上都標有最佳食用日期。建議的儲存溫度和保質期。
- 請用雪櫃內的蛋架儲存雞蛋。

肉類／魚／家禽

- 請將其放在容器上，並包上保鮮紙。
- 若是大塊的肉、魚和家禽肉類，請將其放在層架的內側。
- 已經煮熟的食品應用保鮮紙包好，或將其放在密封容器內。

* 新鮮食品注意事項：

- 新鮮食品（安全包裝）應在限期內儲存，以防止變質和嚴重影響其他儲存的食物。

為達到最佳冷凍效果

- 食品質量應當新鮮。
- 若要快速冷凍食品，每次都必須少量放入。
- 食品應進行恰當密封或蓋緊。
- 將食品均勻地放入冷凍室。
- 袋子和容器上應標記清楚冷凍食品的內容。

防止雪櫃內結露或結霜的建議

- 請確保將食物放在層架或門架上。若食物掉落，將無法關緊門。
- 水分含量高的食品應存放在密封容器內或密封保存。

請注意

- 為使冷空氣充分循環，請將食品均勻地放在層架上。
- 請將較熱的食品涼下來以後，才保存起來。如果將較熱的食品放進雪櫃，雪櫃內的溫度會升高，這樣會導致食品變質。
- 長時間打開門會導致雪櫃內的溫度顯著升高。
- 請勿讓食品和容器擋住冷空氣循環的出風口和吸入口。否則，食品就不能均勻地冷卻。

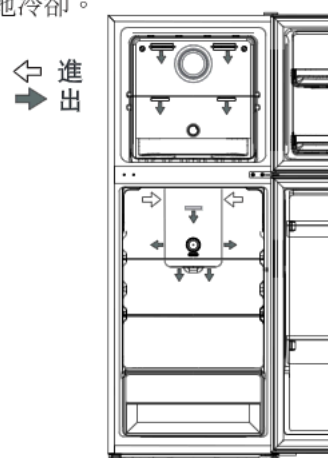

請勿直接將食品放在冷氣出風口旁。
這樣會引致食品凍結。

保養

重要提示

為防止雪櫃內板表面和塑膠部件出現裂紋，請遵循以下操作提示。

- 擦掉黏附在塑膠部件上的食用油。
- 某些家用化學清潔劑可能會導致雪櫃損壞，因此請使用稀釋的清潔劑（肥皂水）。
- 如果使用未稀釋的清潔劑或未徹底擦淨肥皂水，則可能會損壞雪櫃的塑膠部件。

清潔

- 拆下雪櫃的層架和櫃門的儲存架。用溫水和廚房清潔劑清洗，然後清洗乾淨。
- 使用溫水加入適量的廚房清潔劑，將清潔布浸泡肥皂水後扭乾，洗擦雪櫃內部，然後徹底擦拭乾淨。
- 雪櫃的外部沾上污漬時，請用軟布擦拭乾淨。
- 使用溫水加入適量廚房清潔劑和牙刷清洗雪櫃磁性門封。

請注意

- 請勿使用強力清潔劑或溶劑（油漆、塗料、拋光粉、汽油、沸水等），否則可能導致雪櫃損壞。
- 如果拔出電源插頭，請等待至少 6 分鐘後再重新連接電源。
- 請妥善放置雪櫃內的物品，防止掉落，以防造成雪櫃內部品損傷。
- 從雪櫃取出玻璃層架時，確保不要掉落。

除霜

冷卻裝置上的霜（從外面無法看到）會定期融化並流入蒸發盤。之後，水被壓縮機的熱量吸乾。

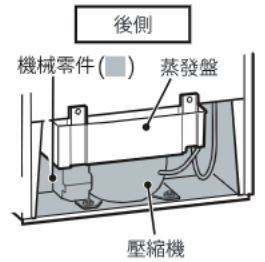

當冷藏室內燈損壞時

請聯繫 SHARP 認可的售後服務中心更換冷藏室內燈。非專業維修人員不可更換冷藏室內燈。

切斷雪櫃的電源時

如需將雪櫃長時間關閉，應遵循以下步驟以減少霉菌增長：

1. 將食物全部取出。
2. 將電源插頭從插座拔出。
3. 將內部徹底清潔乾淨。
4. 將雪櫃門打開數天晾乾。

SHARP

SHARP CORPORATION